

4. Optical Properties of Materials

Part – A

1. What are optical materials?

The materials which are sensitive to light are known as optical materials. These optical materials exhibit a variety of optical properties.

2. What are the types of optical materials?

Based on nature of propagation of light, the optical materials are classified as

- (i) Transparent
- (ii) Translucent
- (iii) Opaque

3. What is transparent materials?

The materials which transmit light with little absorption and reflection. In these materials, one can clearly view the object through the material

4. What is translucent materials?

The incident gets scattered within the material and the diffused light is transmitted with the other side of the material. One cannot clearly view the object through this material

5. What is opaque materials?

The material which absorbs the visible light are called opaque. Here, after interaction of light with material, the light gets reflected or absorbed.

6. What is meant by total incident flux of photon?

It is the sum of the fractional ratios of light transmitted, reflected and absorbed to the energy flux per unit area (J/m^2S).

7. Define scattering of light

It is process by which the intensity of the wave attenuates as it travels through the medium.

8. Define carrier generation and recombination process.

Generation is the process of creating electron and hole pair per volume-second. While the recombination is the process of annihilating the electron and hole pair per unit volume – second.

9. List out the types of carrier generation?

- (1) Photon generation
- (2) Phonon generation
- (3) Impact Ionization

10. List out the types of Recombination?

- (1) Radiative recombination
- (2) Shockley - Read - Hall recombination
- (3) Auger recombination

11. What is the effect of optical absorption in semiconductors?

- (1) It forms excitons
- (2) It produce photoconductivity
- (3) It excites the crystal lattice vibrations
- (4) It excites the free electrons and holes

12. Define trap, its origination and types

It is an intermediate energy levels presents in the energy band gap. These traps arises due to the presence of impurity atoms and imperfections in the crystal. There are two types of trap viz. (1) Trapping centre an (2) Recombination centre

13. Differentiate Trapping centre and Recombination centre

S.No	Trapping centre	Recombination centre
1.	It is a type of trap which captures an electron (or) hole and then reexcite to free state	It is type of trap in which electron an hoke recombines with eachother to produce phonons
2.	Here the charge carriers are temporarily trapped	Here the charge carriers are permanently trapped

14. What is meant by injection luminescence? Give example

When the majority carriers are injected from p to n and n to p region, they become excess minority carriers. Then these excess minority carriers diffuses away from the junction and recombines with the majority carriers in p and n regions and emits light. This phenomenon is known as injection luminescence. Example: LED

15. What is photo diode?

It is a reverse biased $P - N$ junction diode which responds to light absorption

16. Explain the principle of photo diode?

When the light is incident on the depletion region of the reverse biased $P - N$ junction, the concentration of minority charge carriers increases. Therefore, reverse saturation current increases.

17. What is solar cell?

It is basically a large area photo diode which converts sunlight (solar energy) directly in to electricity (electrical energy), with larger efficiency of photon absorption..

18. Explain the term exciton?

An exciton can form when a photon is absorbed by a semiconductor. This excites an electron from the valence band into the conduction band. In turn, this leaves behind a positively charged electron hole . The electron in the conduction band is then effectively attracted to this localized hole by the repulsive Coulomb forces from large numbers of electrons surrounding the hole and excited electron.

19. What is LED?

It is a $P-N$ junction which emits light when it is forward biased.

20. Why is the shape of LED made hemispherical (or) why dome shape LED is preferred than a planar LED.

In planar LED's the emitted light strikes the material interface at an angle greater than the critical angle and the reflection loss will be very high.

Therefore, to minimise the reflection loss, hemispherical dome shape LED is made, in which the angle at which the emitted light strikes the interface can be made less than the critical angle.

21. What is an OLED?

It is solid state device made up of thin films of organic molecules that produce light with the application of electricity.

22. What is the principle of OLED?

An electron moves from the cathode to the emissive layer and the hole moves from the anode to the conductive layer and they recombine to produce photons. This is the principle used to emit light in OLED.

23. Mention any four types of photo diodes

- (1) *PIN* photo diode
- (2) Avalanche photo diode
- (3) Schottky photo diode
- (4) Solar cell

24. What is meant by optical data storage?

The process of storing the data in the storage medium using optical phenomenon is called optical data storage

Example: CD, DVD, etc.,

25. What is the principle of CD?

The data to be stored is first converted into binary form (0 or 1) and stored in the form of reflecting and non-reflecting micro points in spiral path on a disc. During the read out process, variation in the reflected intensity of laser is converted back to data.

26. What is laser diode?

It is a specially fabricated $p - n$ junction diode. This diode emits light when it is forward biased.

27. List out the various optical data storage techniques

- (1) CD - ROM
- (2) CD - RW
- (3) DVD
- (4) Blu-ray Disc
- (5) Magneto optical disc
- (6) Holography.

28. What are the advantages of optical data storage?

- (1) Immune to dust
- (2) Relatively inexpensive
- (3) Storage capacity is high
- (4) It is removable

29. What are activators and co activators?

The impurity ions which leads to the production of traps are called activators.

The ionic charges present along with the impurities are called co-activators

Part – B

1. Describe absorption and emission of light in metal, insulator and semiconductor

Metals

Metals are **opaque** because of the incident light radiation excites electrons into unoccupied energy states above the Fermi energy. As a result the incident radiation is absorbed. Total light absorption is within a very thin outer layer usually less than $0.1 \mu m$. Hence metallic films thinner than $0.1 \mu m$ are capable of transmitting visible light. Moreover metals are **opaque** at lower frequencies (radio frequency to mid of ultraviolet radiation) and **transparent** to high frequency

X – rays and γ rays. Most of the absorbed radiation is reemitted from the surface in the form of visible light of same wavelength which appears as **reflected light**. The reflectivity in the most of the materials will be between 0.9 and 0.95. The colour of a metal is determined by the wavelength distribution of the reflected radiation.



Insulators

Absorption of a light photon may occur in an insulator. It results in excitation of an electron from valence band to conduction band after crossing the energy gap E_g . A free electron in the conduction band and a hole in the valence band are created. The excitation of an electron due to absorption of light can take place only if the light photon energy ($\Delta E = h\nu$) is greater than that of band gap E_g .

i.e., $\Delta E = h\nu$.

Here, light photon absorption takes place only when $h\nu > E_g$

(or) $hc/\lambda = E_g$.

Thus, for a visible light the wavelength is typically of about $0.4\mu\text{m}$, then the band gap energy for the light is about 3.1 eV . Thus no visible light is absorbed by materials having band gap energies greater than about 3.1 eV . These materials appears transparent and colourless if they are high purity state.

Semiconductors

In semiconductors, light photons is absorbed in several ways. In intrinsic semiconductors light photons is absorbed to create electron - hole pairs. This absorption causes electrons to jump across the energy band gap from the valence band to the conduction band. Hence the excitation of electrons due to absorption can takes place if the photon energy is greater than that of the band gap E_g , The maximum wavelength for visible light λ_{max} is about $0.7\mu\text{m}$. Therefore the minimum bandgap energy $E_{g(min)}$ for which there is absorption of visible light is given by $E_{g(min)} = hc / \lambda_{max}$ Here, $E_{g(min)}$ is found to be 1.8 eV . Hence all visible light is absorbed by those semiconductors having band gap energies less than about 1.8 eV , thus these semiconductors are **opaque**.

In extrinsic semiconductors, the presence of acceptor and donor impurities creates new energy levels namely acceptor level (p - type) and donor level (n - type). These impurity level lie within the bandgap of the material. Light radiation of specific wavelength may be absorbed as a result of electron transitions from or to these impurity levels within the band gap.

2. Explain carrier generation and recombination in semiconductor

Carrier generation:

It is the process of generating number of hole - electron pairs per unit volume second. Basically there are three types of carrier generations.

(i) **Photo generation**

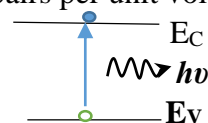

When a photon is incident with energy $h\nu$ greater than the energy of band gap of a semiconductor, then the electrons in valence band absorb this photon and jump to conduction band thereby generating electron - hole pair. For different wavelengths of light with different energies it can take an electron in higher conduction band states.

(ii) **Phonon generation**

When a semiconductor is under thermal excitation, with increase of temperature of the semiconductor, lattice vibrations increase which give rise to more phonons. Due to more lattice vibrations, covalent bonds in the semiconductor break down and electron - hole pairs are generated.

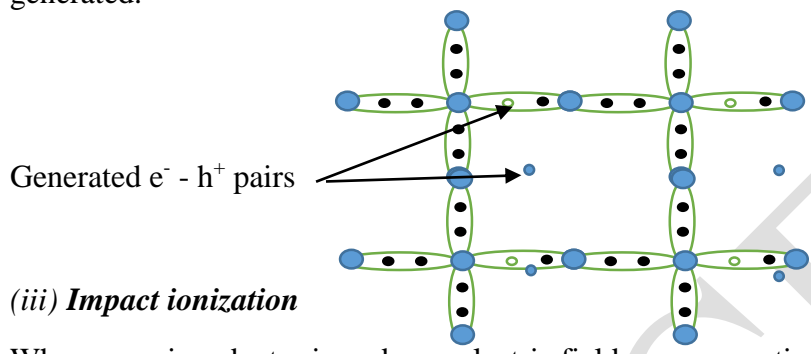

(iii) **Impact ionization**

When a semiconductor is under an electric field, one energetic charge carrier will create another charge carrier. For a very high electric field, it results in an avalanche breakdown.

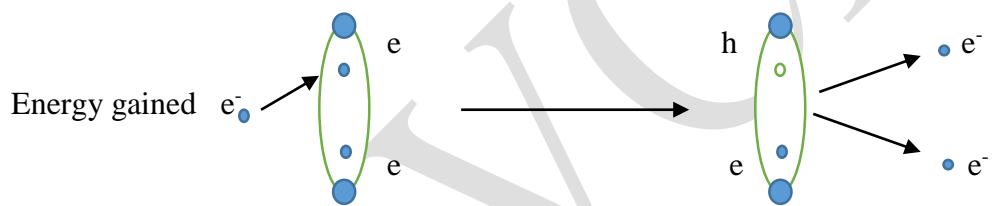

Recombination:

It is a process in which the electron - hole pair are annihilated during recombination per volume second. Recombination occurs in three ways:

(i) **Radiative recombination**

This process occurs in direct band gap semiconductor. When an electron in the conduction band minimum falls to valence band maximum without change in momentum. One photon of energy $h\nu$ is emitted. This is direct recombination. Here the electrons in the highest energy states of conduction band will come back to conduction band minimum by non radiative transition (heat).

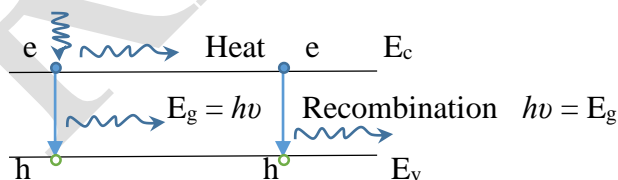

(ii) **Shockley - Read - Hall recombination**

In this process, electrons from the conduction band minimum or holes from the valence band maximum are come to a defect level intermediate between E_c and E_v by radiation energy as photons or phonons. These intermediate levels are called trapping level. Hence either the electron or the hole from the trapping level returns to the valence band or conduction band. They are not set free & hence it is said to be trapping level. Generally this process occurs in impure semiconductors.

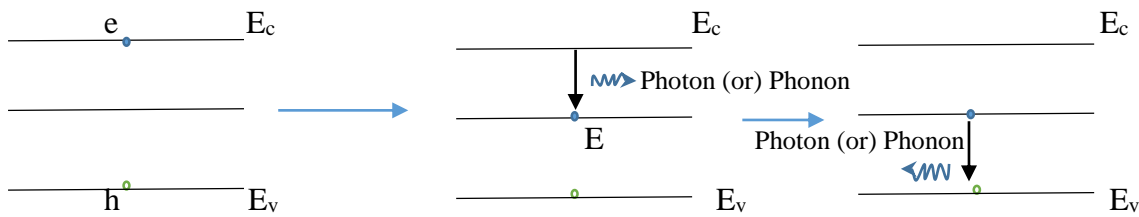

(iii) Auger recombination

Here three carriers are involved. i.e., the electron and hole recombine may have an energy which is given to the third free electron in the conduction band. Then the excited third electron comes back to the conduction band edge by emitting energy as heat. Generally an Auger recombination occurs for heavily doped material.

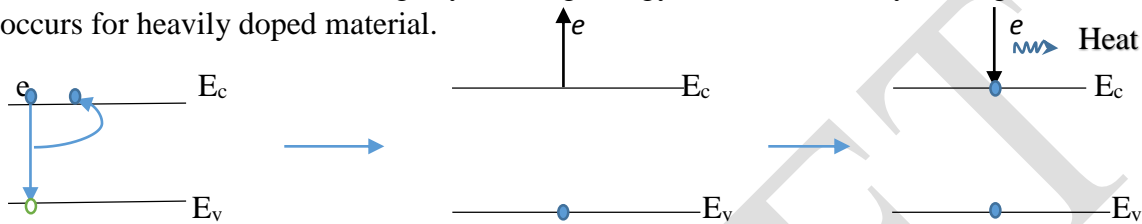

3. Describe the construction and working of photodiode

It is a reverse biased *p - n* junction diode which responds to light absorption.

Principle

When light is incident on the depletion region of the reverse biased *pn* junction, the concentration of minority carrier increases. Therefore, reverse saturation current increases.

Construction

A photo diode consists of a *p - n* junction which is placed in a transparent plastic capsule as shown in figure. Light is allowed to fall on the surface of the junction. The symbol of the photodiode is shown in figure.

Working

When the photo diode is kept under dark condition and a voltage is applied, then a constant current independent of reverse bias voltage is obtained. This reverse saturation current is due to thermally generated minority carriers. It is called dark current (I_d) and is proportional to the concentrations of minority carriers

When the light falls on the diode surface, additional electron - hole pairs are generated. These injected minority carriers diffuse to junction and contribute to the additional current.

Thus under reverse bias conditions, total reverse current is given by $I = I_d + I_s$

Where I_s is the short circuit current and it is proportional to the intensity of light. The *I - V* characteristic curve of photo diode shows that

- (1)The current increases with increase in the level of illumination for a given reverse voltage.
- (2)Only for the dark current at zero voltage the current is zero.

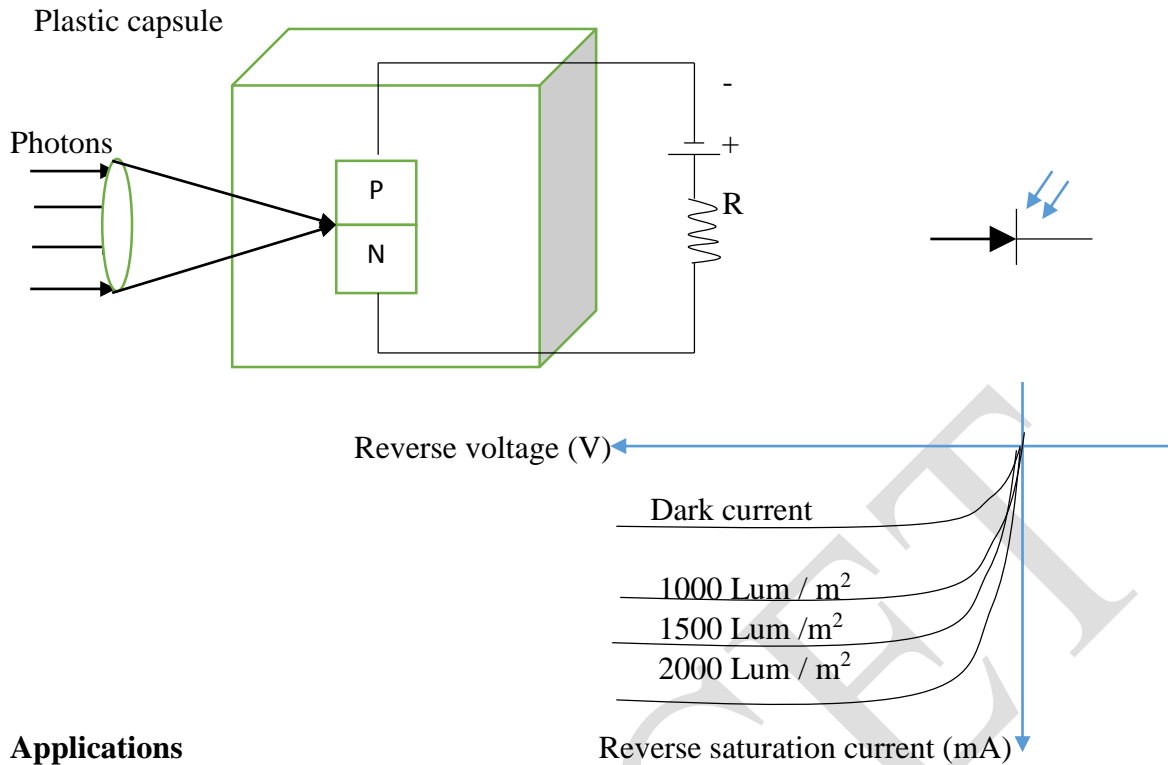

Applications

- Light detection systems
- Reading of sound track in film
- Light operated switches
- Used as variable resistance device controlled by light intensity
- Used to switch on the current at a very fast rate.

4. Explain the construction and working of solar cell. Also discuss the advantages, disadvantages and its applications.

It is a *p - n junction* diode which converts solar energy (light energy) in to electrical energy.

Construction

It consists of *p - n junction* diode made of silicon. The *p - n* diode is packed with glass window on top such that light may fall up on *p* and *n* type materials. The symbol of the solar cell is shown in figure.

The thickness of *p* and *n* regions are kept very small. As a result electrons or holes generate near the surface of *p* or *n* region can diffuse to the junction before they recombine. A nickel ring is provided at the top of the *p* layer which acts as the positive output terminal. A metal contact at the bottom serves as the negative output terminal.

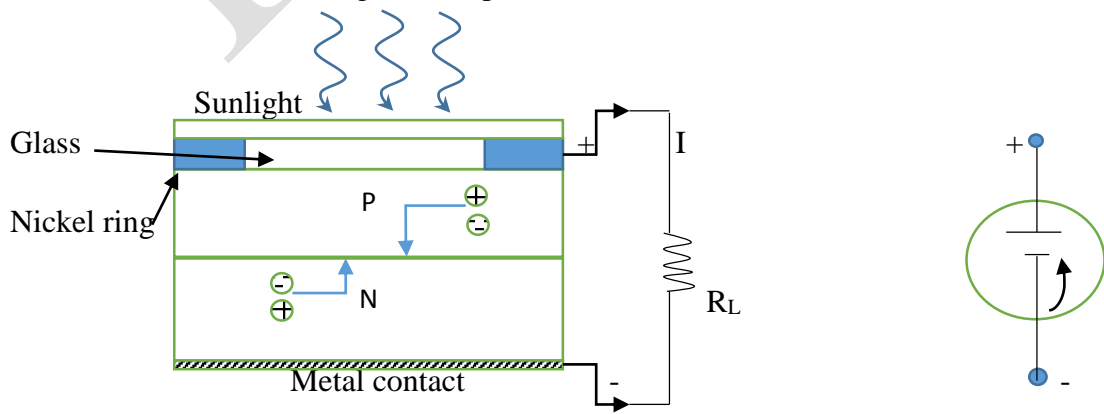

Working

When light radiation from sun falls on the $p - n$ junction diode, the photon energy is sufficient to break the covalent bond and produce electron hole pair. These electrons and holes reach the depletion region by diffusion and they are separated by the strong barrier electrical field existing there.

The minority carrier electrons in the p - side cross the barrier potential to reach n side and the holes in n - side move to the p - side. Their flow constitutes the minority current which is directly proportional to the illumination of light and the surface area being exposed to light.

The electrons and holes accumulated on either sides of junction leads to open circuit voltage V_{oc} as a function of illumination. In case of silicon solar cell, V_{oc} is typically $0.6V$ and the short circuit current is about 40 mA/cm^2 in bright noon day sun light. The $I - V$ characteristics of solar cell shows maximum power output when the solar cell is opened at the knee of the curve

Advantage:

- (1) It operates with fair efficiency
- (2) It can be mass produced
- (3) It has high power capacity per weight
- (4) Its size is small and compact.

Disadvantage

- (1) Solar energy is not available during winter season and night time
- (2) We need an additional equipment like inverter to store the electrical energy
- (3) The output which is in DC is converted to AC

Uses

- (1) It is used in satellites and space vehicles to supply power to electronic and other equipment's
- (2) It is used to give power to the calculators and watches
- (3) They are used to provide commercial electricity.

5. Explain the construction and working of a LED with energy band diagram. How the Planar LED is differ from dump shaped LED?

Principle

Injection luminescence is the principle used in LED. When $p - n$ junction (LED) is forward biased, the majority carriers moves from p to n region and vice versa. These excess minority carriers diffuse through the junction and recombine with majority charge carriers respectively to produce (light) photons.

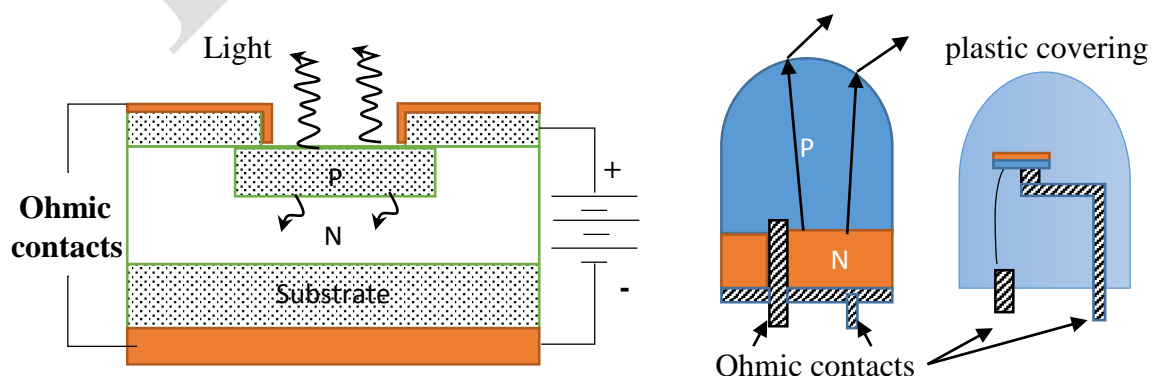

Fabrication

Here n - type layer is grown on a substrate and p - type layer is deposited above it by diffusion. p type is grown as a top layer because of the recombination process takes in this region. For maximum light emission, a metal film anode is deposited at the outer edges of the p - type layer and the bottom of the substrate is coated with gold film (metal). This metal surface reflects the light and also act as cathode.

Working

- (1) When a p - n junction is forward biased, the barrier width is reduced, raising the potential energy on the n side and lowering that of the p - side
- (2) The free electron and hole have sufficient energy to move to the junction region.
- (3) If a free electron recombine with a hole it will release a photon (light)
- (4) This photons created in LED are due to electron and hole recombination that are injected into the junction by a forward biasing voltage.

Advantages

- (1) Smaller in size
- (2) Cost is very low
- (3) Long life time
- (4) Available in different colour at low cost
- (5) Operates at very low voltage
- (6) Fast response time (10^{-9} seconds)
- (7) Operated at wide range of temperatures ($0 \sim 70^{\circ}\text{C}$)
- (8) Dome shaped LED has less scattering loss

Disadvantages

- (1) Power output is low
- (2) Intensity is less than laser
- (3) Light cannot travel through long distance
- (4) Light output is incoherent and not in phase

Dome shaped LED

In planar LED, the reflection loss is more because of the emitted light strikes at the materials surface at an angle greater than critical angle and suffers total internal reflection. Hence it will not come out of the interface and the light is lost. Hence by making p type in hemispherical shape or by covering the p - n junction diode by a hemispherical plastic medium of higher refractive index, the reflection loss is eliminated.

6. Write a brief note on OLED?

Principle

An electron moves from the cathode to the emissive layer and hole moves from the anode to the conductive layer and they recombine to produce photons.

Fabrication

The 2 - layer OLED consists of two organic layers in between a cathode and an anode.

The two organic layers are (i) emissive layer (ii) conductive layer, made up of different conductivities. All the layers are grown over a transparent substrate, through which the light has to be emitted. Necessary biasing is given to OLED in such a way that the anode is given positive and the cathode is given negative as shown in figure.

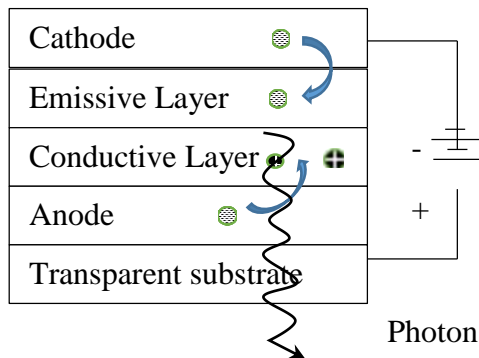

Working

- (1) Voltage is applied across the OLED
- (2) Due to the applied voltage, the cathode gives electrons to the emissive layer
- (3) The anode withdraws the electron from the conductive layer and creates a hole in the conductive layer as shown in figure.
- (4) That is the anode gives (electron – hole) **polarons** a quasi-particle - a positive (or) negative ion slightly attracted to a negatively (or) positively charged carriers respectively.
- (5) Soon, the emissive layer has a large number of negatively charged particles and the conductive layer has a large number of positively charged particles.
- (6) Due to electrostatic forces between these electrons and holes, they come closer and recombine with each other.
- (7) In OLED, the recombination occurs closer to the emissive layer, because in organic semiconductors, holes move faster than electrons.
- (8) Thus, the recombination of electrons and holes produces photons and is emitted through the transparent substrate as shown in figure.

Advantages

- (i) It is very thin and more flexible
- (ii) They are light in weight
- (iii) Light emission is brighter than normal LEDs
- (iv) The conductive and emissive layers can be increased to increase the efficiency of OLED
- (v) OLED does not require backlighting like LCD
- (vi) They have a large field of view (about 170°)

Disadvantages

- (1) Manufacturing cost is high
- (2) It gets damaged easily when water falls on it
- (3) Blue OLED has less life time than Red OLED

Applications

- (1) It is widely used in cell phones, digital cameras, etc.,
- (2) It is used in TV screens, computer monitors
- (3) Use in automotive dash boards, backlights in cars

Types

- (1) Polymer Light Emitting diode (PLED)
- (2) Patternable Organic Light Emitting Diode (POLED)
- (3) Transparent Organic Light Emitting Diode (TOLED)
- (4) Stacked Organic Light Emitting Diode (SOLED)
- (5) Inverted Organic Light Emitting Diode (IOLED)

7. Describe the construction and working of a semiconductor laser (homojunction) with necessary diagrams. Also compute its advantages, disadvantages and applications?

Principle

When a $p - n$ junction diode is forward biased the electrons from $n -$ region and the holes from $p -$ region cross the junction and recombine with each other. During the recombination process the photons (light radiation) is released from direct band gap semiconductor (Eg: GaAs) which stimulates other electrons and holes to recombine and hence the stimulated emission takes place which produces the laser

Construction

The basic construction of a semiconductor homojunction diode is shown in the figure

Laser output

The active medium is a $p - n$ junction diode made from a single crystal of GaAs. This crystal is cut in the form a platelet of thickness 0.5mm. this platelet has an electrical (n -type) and hole conductivities (p -type)

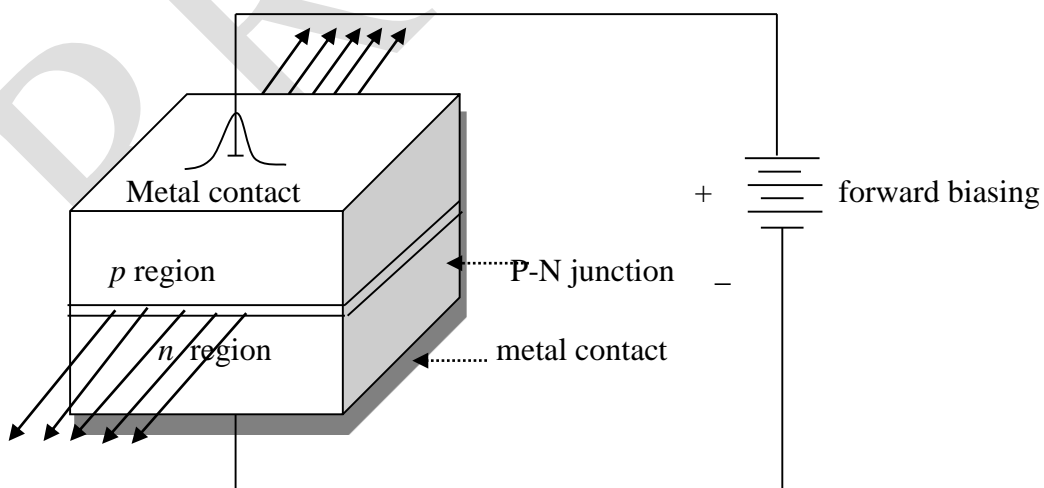

The photon emission is stimulated by a thin layer of PN junction. The potential difference is applied to the homojunction diode through the metal contact .the end faces of the junction are polished and made parallel to each other. They act as optical resonator (the diode has high refractive index) where the laser comes out.

Working

Figure shows the energy level diagram. When the diode is forward biased using the applied potential difference, the electron and holes are injected in to the junction where the concentration of holes in p – region and electrons in n - region strengthens. After the population inversion condition is achieved, the electrons and holes are recombined to produce a radiation in the form of light

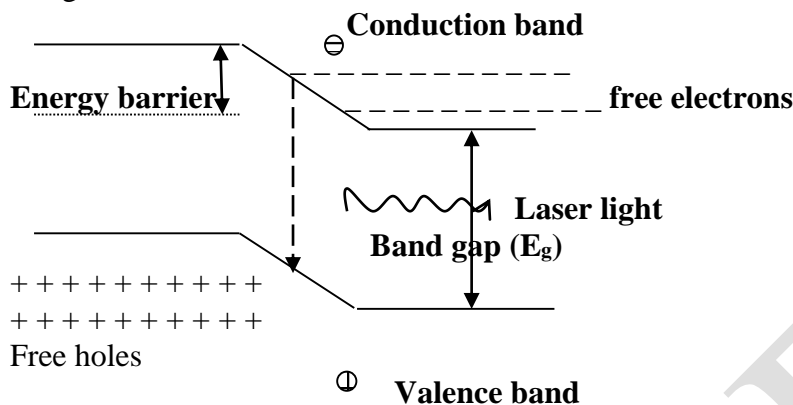

When the forward biased voltage is increases, the emitted photon multiplies and triggers these recombining photons in phase. These photons moving at the plane of junction travels back and forth by reflection between two sides of the junction and grows in strength. After gaining enough strength it emits a laser beam of wavelength 8400Å . The wavelength of emitted radiation depends on (i) band gap & (ii) the concentration of donor & acceptor atoms. The wavelength of laser light is given by $E_g = h\nu$ (or) $\lambda = \frac{hc}{E_g}$ where E_g – band gap energy & $\nu = c / \lambda$

Characteristics

01.	Type	Solid state homojunction semiconductor laser
02.	Active Medium	PN junction GaAs diode
03.	Pumping Method	Direct conversion method
04.	Power output	1mW
05.	Nature of Output	Continuous (or) Pulsed
06.	Wavelength	8400 Å

Advantages

- (i) It is small in dimension and compact
- (ii) It exhibits high efficiency
- (iii) The laser output can be increased easily by controlling junction current
- (iv) It requires little auxiliary equipment

Disadvantages

- (i) It is difficult to control mode pattern and structure of laser
- (ii) Output beam has large divergence
- (iii) Monochromaticity is poorer than other type of laser
- (iv) Threshold current density is large

Applications

- (i) It is used in optical communication
- (ii) It is used to heal the wounds by infrared radiation

(iii) It is used in CD writing and reading

8. Describe the construction and working of a Heterojunction semiconductor laser with necessary diagrams. Also compute its advantages, disadvantages and applications?

Principle

When a *p - n* junction diode is forward biased, the electrons from *n*- region and holes from *p* - region recombines with each other at junction and emits photons in the form of light at certain direct band gap semiconductor

Construction

This laser consists of five layers as shown in figure. A layer of GaAs - *p* type act as active medium (3rd layer). This layer is sandwiched between two layer of GaAs - *p* type & GaAs -*n* type with wide band gap. The electrical voltage is applied at the extreme layers and the 3rd & 4th layers are polished and made parallel to each other. They behave as optical resonator

Working

When the PN junction is forward biased, the electrons and holes are injected into junction. The region around junction has large no of electrons in conduction and large no of holes in valence band. Hence the population inversion is achieved. As a result recombination electrons and holes produce photons as light radiation. When the forward biasing voltages increases, the stimulated recombination increases the intensity of photons and they are in phase. This photon travels back and forth at junction due to reflection and grows in strength. A coherent laser beam of wavelength 8000 Å is emitted at the junction.

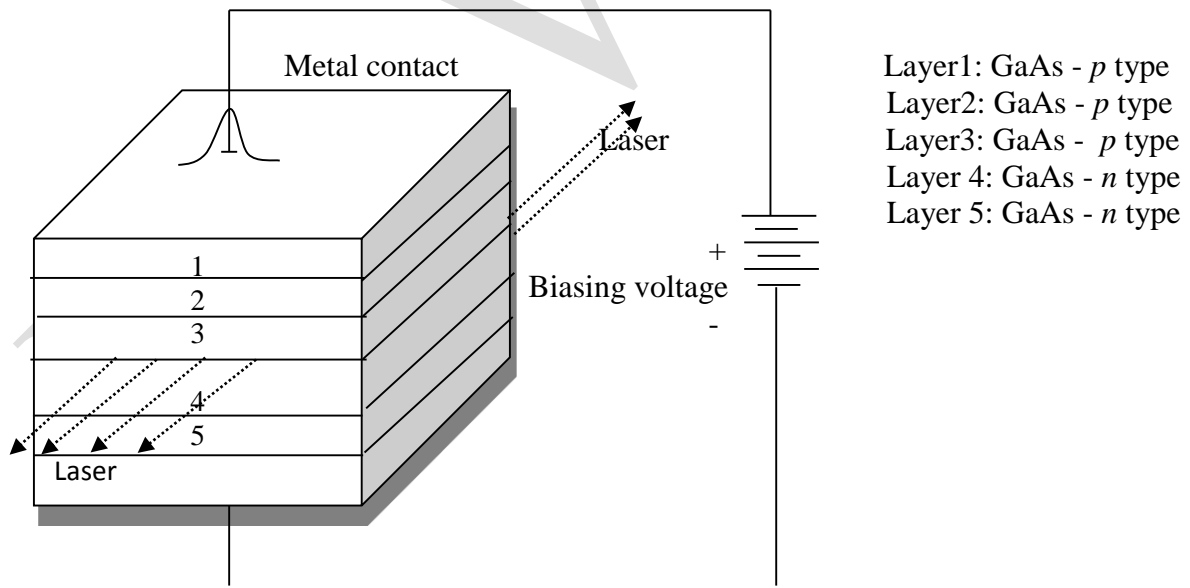

Characteristics

01.	Type	Solid state Heterojunction semiconductor laser
02.	Active Medium	<i>p - n</i> junction made from different layers
03.	Pumping Method	Direct conversion method
04.	Power output	1mW
05.	Nature of Output	Continuous
06.	Wavelength	8000 Å

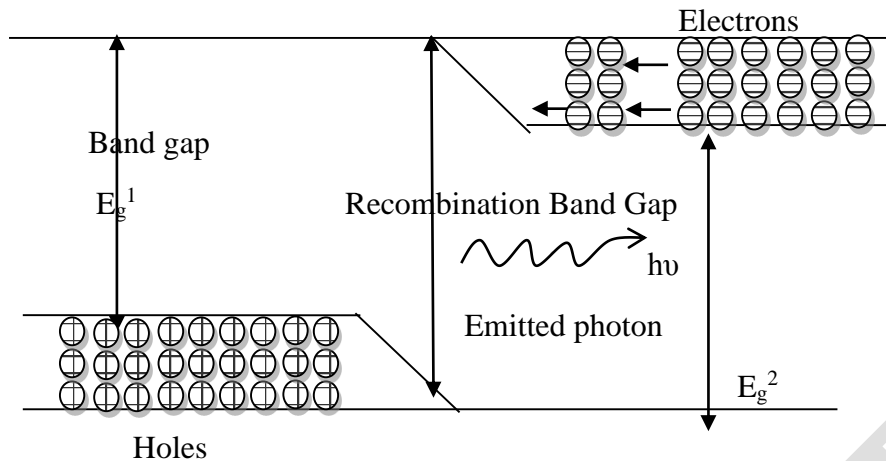

Advantages

- (i) It produces continuous wave output
- (ii) The power output is high

Disadvantages

- (i) It is difficult to grow different layers of a $p-n$ junction
- (ii) The cost is high

9. Explain optical storage techniques?

The optical data storage techniques resulted in increased storage capacities after the invention of laser. In general they are classified as surface storage and volume storage.

Optical tape

For many years photosensitive film roles are used as optical tapes for recording optical information. Even acoustical information are recorded in such tapes as sound tracks.

Optical Disc (CD)

Principle

The data to be stored is first converted into binary form as 0's and 1's. it is then store in the form of reflecting and non-reflecting micro points in spiral path on a disc. During the read-out process, variation in the reflected intensity of laser is converted back to data.

This optical disc is further classified as *reading only* and *Recording and reading type* based on their storage technique and capabilities. However in either type's laser diode, lenses and photodiodes are used.

During recording, it change electrical information into optical information and then records the information on the optical disc. While reading the head optically reads the recorded information and changes the optical information in to electrical information. The commercial system make use of discs that are 90, 120, 130 and 300nm in diameter. A mini disc, 64nm in diameter is also used for digital audio.

CD audio

The substrate of the disc is either plastic or photo polymer. First audio signal to be stored is stored is converted into binary. This is then stored in the form of reflecting and non – reflecting micro points in spiral path on a on a metallic master using sharply focussed laser beam. The digital data is pressed onto the substrate by injection moulding. Thus mass production of the CD form base on this concept.

CD ROM

This is similar to that of CD audio with a difference that here in this case video signal is converted into binary and stored in a metallic master. The data thus replicated from the master on a plastic substrate can be read any number of times but cannot be changed and hence this name.

CD – WORM

In this the active layer is chemically coated on the substrate. The laser pulses generated in the CD writer burns the chemical coating and there by creates reflecting and non-reflecting micro points. We can write the data once and read any number of times but the data written cannot be either copied or erased and rewritten and hence the name. For copies each disc has to be written burning the chemical coating. This technique we use to record functions such as marriages, etc.,

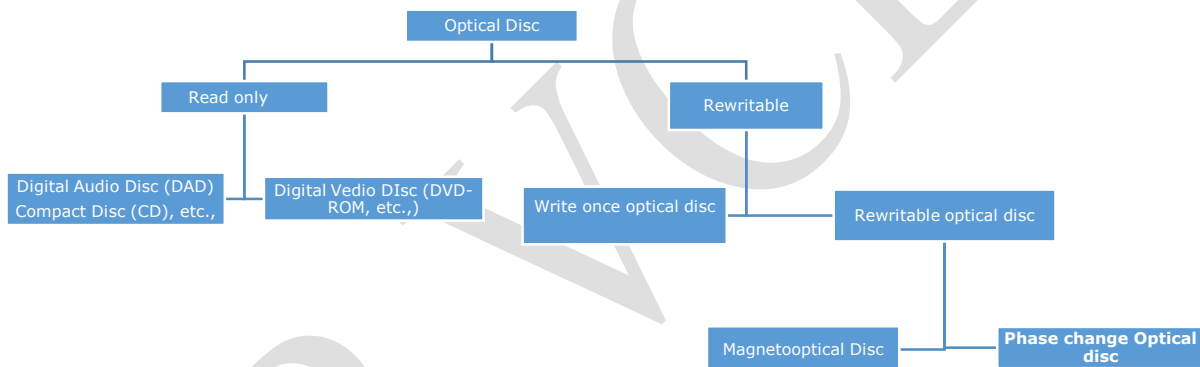

CD R/W

In this type of CD we can write the data, read and rewrite after erasure. For this two different materials / phenomena via phase change materials and magneto-optic materials are used in general.

Digital Versatile Disc (DVD)

In 1996, a new read only optical system called digital versatile disc with enough capacity (4.7GB) to hold 130 minutes of compressed video, or more than 90% of all feature-length movies using laser of shorter wavelength and focusing lens of larger numerical aperture is introduced. Then DVD R/W also introduced.

Digital Video Recording (DVR)

With this system, 22GB can be recorded on a single layer of 12cm disc. The most important commercial application of this system is recording of high definition digital video. By reducing the spot size using a laser of shorter wavelength and objective lens of higher numerical aperture a real density is increased.

Advantages of optical disc

The optical discs have several advantages over semiconductor memories. Some of these include their larger data storage capacity, shorter access time size. Therefore they are used in terminal equipment of computers as well as in audio visual equipment.

Read only optical discs equipment

CD's which are 120mm in diameter are typical digital audio discs. Compact discs usually means digital audio compact discs, but it also includes the read only memory (CD-ROM) for data memory and interactive compact disc (CD-I) for multimedia use. Audio information (sound) is digitally recorded in stereo on the surface of a CD in the form of microscope "pits" and flats". The light emitted from the laser diode passes through the lens and it is focussed to a diameter of about 1mm on the surface of a disk. As the CD rotates, the lens and beam follow the track under control of a servo motor. The laser light which is altered by the pits and flats along the recorded track is reflected back from the track through the lens and optical system to infrared photodiodes. The signal from the photodiodes is then use to reproduce the digitally recorded sound.

